

ASM235CM Datasheet

USB Type-C USB 3.1 Gen 2/Gen 1 to
SATA Bridge Controller

ASMedia Confidential

Copyright Notice:

Copyright © 2017, ASMedia TECHNOLOGY INC. All Rights Reserved.

INFORMATION IN THIS DOCUMENT IS PROVIDED IN CONNECTION WITH PRODUCTS OF ASMEDIA TECHNOLOGY INC. NO LICENSE, EXPRESS OR IMPLIED, BY ESTOPPEL OR OTHERWISE, TO ANY INTELLECTUAL PROPERTY RIGHTS IS GRANTED BY THIS DOCUMENT. EXCEPT AS PROVIDED IN ASMEDIA'S TERMS AND CONDITIONS OF SALE FOR SUCH PRODUCTS, ASMEDIA ASSUMES NO LIABILITY WHATSOEVER, AND ASMEDIA DISCLAIMS ANY EXPRESS OR IMPLIED WARRANTY, RELATING TO SALE AND/OR USE OF ASMEDIA PRODUCTS INCLUDING LIABILITY OR WARRANTIES RELATING TO FITNESS FOR A PARTICULAR PURPOSE, MERCHANTABILITY, OR INFRINGEMENT OF ANY PATENT, COPYRIGHT OR OTHER INTELLECTUAL PROPERTY RIGHT.

Products of ASMEDIA TECHNOLOGY INC. are not intended for use in medical, life saving, life sustaining, critical control or safety systems, or in nuclear facility applications.

ASMedia may make changes to specifications and product descriptions at any time, without notice.

ASMedia TECHNOLOGY INC. may have patents or pending patent applications, trademarks, copyrights, or other intellectual property rights that relate to the presented subject matter. The furnishing of documents and other materials and information does not provide any license, express or implied, by estoppel or otherwise, to any such patents, trademarks, copyrights, or other intellectual property rights.

Contact your local ASMedia sales office or your agent to obtain the latest specifications and before placing your product order.

Copies of documents which have an order number and are referenced in this document, or other ASMedia literature may be obtained by calling +886-2-22196088 or by visiting ASMedia's website at www.asmedia.com.tw.

ASMedia and ASMedia logo are trademarks or registered trademarks of ASMedia TECHNOLOGY INC. in Taiwan and other countries.

© 2017 祥碩科技股份有限公司，著作權所有，並保留一切權利

本文資料為與祥碩科技股份有限公司之產品相關。本文並未明示或默示授權任何智慧財產權予第三人。除在祥碩科技股份有限公司對該產品提供的買賣條款及條件以外，祥碩科技股份有限公司免於擔負任何責任，且不對產品的買賣及使用做任何明示或默示的保證，包含產品適於特殊使用目的、以及產品不侵害任何專利權、著作權或其他智慧財產權。祥碩科技股份有限公司之產品不用於醫療的、救助生命的、生命維持的、安全控管系統或核子設施等用途之上。

祥碩科技股份有限公司可隨時不經通知，逕行增訂或修改產品規格及描述。

本文之相關專利權、申請中之專利權、商標權、著作權及其餘智慧財產權均屬祥碩科技股份有限公司所有。本文及其他資訊並未明示或默示的提供任何專利、商標、著作權及其餘智慧財產權之授權。

請於下產品訂單前，先聯絡當地的祥碩科技銷售處或代理商以取得最新的產品規格書。

本文提及之有訂單號碼之文件或其他詳細資料可參閱祥碩科技網站 www.asmedia.com.tw 或撥打 +886-2-22196088

ASMEDIA 和 ASMEDIA 商標均為祥碩科技股份有限公司在台灣和其他國家的註冊商標或商標。

Office:

ASMedia Technology, Inc.

6F, No.115, Minquan Rd., Xindian City, Taipei County 231, Taiwan, R.O.C.

<http://www.asmedia.com.tw>

Tel: 886-2-2219-6088

Fax: 886-2-2219-6080

USB Type-C™ and USB-C™ are trademarks of USB Implementers Forum



Environmentally hazardous materials are not used in this product.

Revision History

Rev.	Date	Description
0.1	February 26, 2016	Initial Release
0.2	July 28, 2016	Added CC Analog Signal Electrical Characteristics Added description in the features to exclude 28-bit LBA devices from the support list Updated thermal information
0.3	July 29, 2016	Updated Thermal Information
0.4	September 21, 2016	Added a note about VBUS_LDO input in pin description Removed built-in 5.1K-ohm in CC Analog Signal Electrical Characteristics
0.5	October 7, 2016	Updated the timing diagram of power on sequence Updated the tables of DC Electrical Characteristics for VBUS, GPIO, RST# pins
0.6	November 24, 2016	Added USB Type-C CC Channel Specification Updated description of the timing diagram of power on sequence
0.7	March 10, 2017	Updated power on sequence timing diagram and table
1.0	July 5, 2017	Updated ESD Updated parameter of ΔV_N (p-p) in Internal Switching Regular Electrical Specification Added Top Marking
1.1	Dec 21, 2017	Added description about HDDPC implementation in Pin Descriptions

ASMedia Confidential

Table of Contents

Revision History	iii
Table of Contents	iv
List of Figures	v
1. General Description	1
2. Features	1
3. Package Type	2
4. Functional Diagram	3
5. Pinout Diagrams	4
6. Pin Descriptions	5
7. Electrical Characteristics	7
7.1 Absolute Maximum Ratings	7
7.2 Recommended Operating Conditions	7
7.3 DC Electrical Characteristics for VBUS pin	8
7.4 DC Electrical Characteristics for GPIO pins	8
7.5 DC Electrical Characteristics for RST# pins	8
7.6 External Crystal Electrical Specification	9
7.7 Differential Clock Oscillator Electrical Specification	9
7.8 Internal Linear Regular Electrical Specification	9
7.9 Internal Switching Regular Electrical Specification	10
7.10 Internal USB Data Switch Specification	10
8. Power on Sequence	11
9. PCB Design Guide under Thermal Pad	12
10. Package Information	13
11. Top Marking Information	15

ASMedia Confidential

List of Figures

Figure 1: Functional Diagram of ASM235CM	3
Figure 2: ASM235CM Pinout	4
Figure 3: Differential Crystal Design	9
Figure 4: Timing diagram	11
Figure 5: Symbol 1 for via design rule under Thermal pad.....	12
Figure 6: Mechanical Specification – QFN 48L.....	14

ASMedia Confidential

This page is intentionally left blank.

ASMedia Confidential

1. General Description

Engaged in Universal Serial Bus I/O solutions and storage application developments, ASMedia Technology is committed on expanding product portfolio with introducing a new generation of USB 3.1 to SATA 6Gbps bridge solution for USB Type-C storage application.

ASM235CM is the latest generation of ASMedia's single chip solution, bridging the USB3.1 to Serial ATA host interface with highly integrated SuperSpeedPlus, SuperSpeed, High Speed, SATA 1.5/3.0/6.0 Gbps ASMedia self-designed PHYs as well as built-in CC logic circuit enabling reversible USB cable orientation and direction. Along with excellent compatibility with USB3.1 hosts and SATA devices, ASM235CM utilizes advanced process technology to optimize the chip power consumption.

Customers can easily enhance their storage device performance with ASM235CM since it also integrates an 8-bit micro-processor and embedded RAM to provide a cutting edge solution in USB to SATA device enclosure market.

2. Features

- ◇ Compliant with USB3.1 Specification Revision 1.0
- ◇ Compliant with Type-C Specification Revision 1.1
- ◇ Compliant with USB Specification Revision 2.0
- ◇ Support USB Super-Speed Plus, USB Super-Speed, High-Speed and Full-Speed Operation
- ◇ Support USB Mass Storage Class, Bulk-Only Transport Specification Revision 1.3
- ◇ Support USB Attached SCSI Protocol Specification Revision 1.0
- ◇ Compliant with Serial ATA Specification Revision 3.2
- ◇ Serial ATA bus up to 6Gbps Signal bandwidth
- ◇ Support Spread Spectrum Control of USB3.0 and SATA interface to improve the EMI performance
- ◇ Support ATA/ATAPI Packet Command Set
- ◇ Support ATA/ATAPI LBA48 addressing mode(28-bit LBA SATA devices are not supported due to OS limitations)
- ◇ Integrated 8-bit micro-processor with embedded program RAM and ROM
- ◇ Support SPI NVRAM for Vender Specific Application of USB Device Controller
- ◇ Support multi-GPIO pins
- ◇ Support programmable PWMs
- ◇ Support 25 MHz with external crystal mode
- ◇ Integrated two internal voltage regulator for IO power and Core

3. Package Type

- ◇ Green Package 6x6 QFN 48L (Pb-free)

ASMedia Confidential

4. Functional Diagram

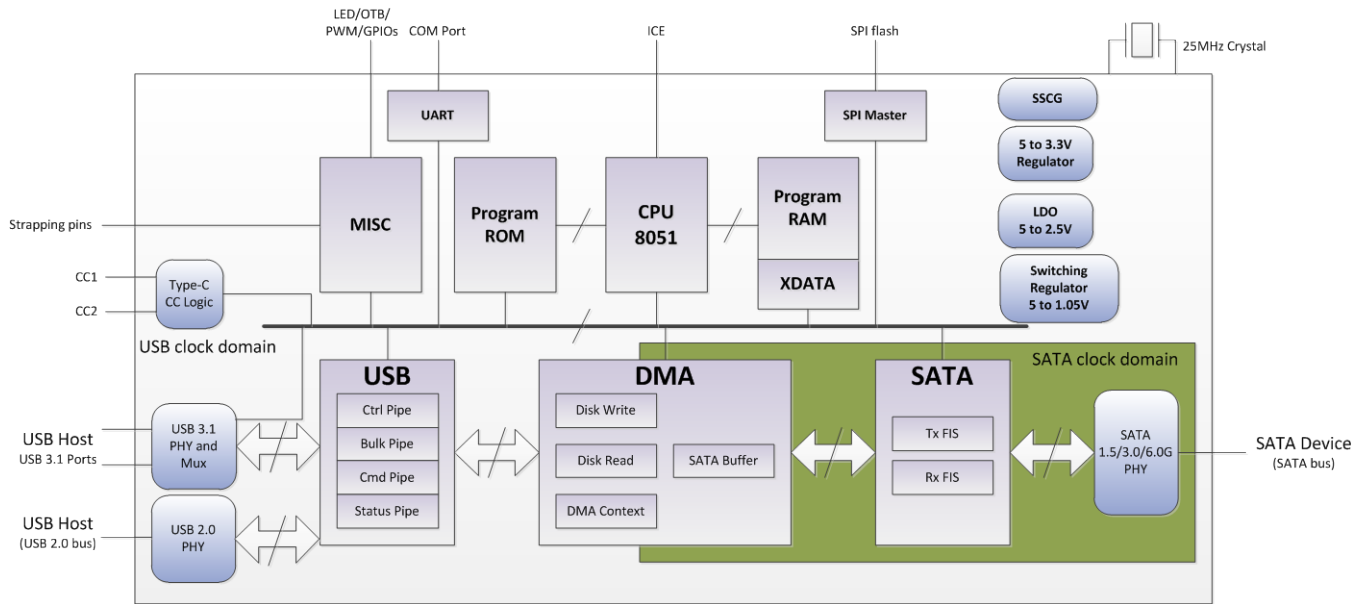

Figure 1: Functional Diagram of ASM235CM

ASMedia.com

5. Pinout Diagrams

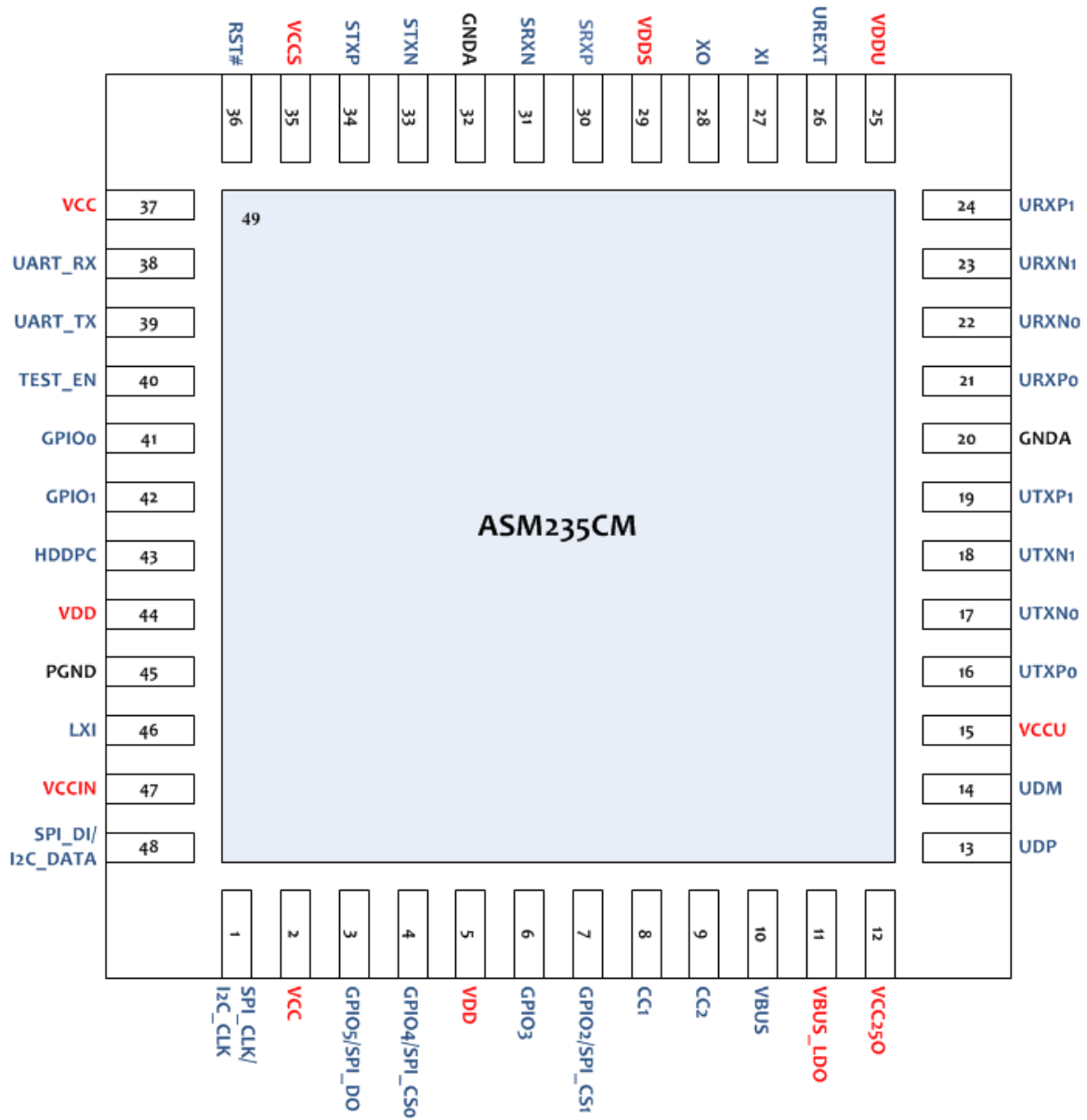

Figure 2: ASM235CM Pinout

6. Pin Descriptions

This section provides a detailed description of each signal. The following notations are used to describe the signal type.

I/O Type	Definition
I	Input pin
O	Output pin
B	Bi-directional pin
P	Power pin
G	Ground pin
OD	Open Drain

Pin No.	Name	TYPE	Descriptions
USB interface			
14	UDM	B	USB2.0 negative Data Signal
13	UDP	B	USB2.0 positive Data Signal
17	UTXN0	O	SuperSpeedPlus USB negative Transmitter Signal for port0
16	UTXP0	O	SuperSpeedPlus USB positive Transmitter Signal for port0
22	URXN0	I	SuperSpeedPlus USB negative Receiver Signal for port0
21	URXP0	I	SuperSpeedPlus USB positive Receiver Signal for port0
18	UTXN1	O	SuperSpeedPlus USB negative Transmitter Signal for port1
19	UTXP1	O	SuperSpeedPlus USB positive Transmitter Signal for port1
23	URXN1	I	SuperSpeedPlus USB negative Receiver Signal for port1
24	URXP1	I	SuperSpeedPlus USB positive Receiver Signal for port1
SATA interface			
30	SRXP	I	SATA positive Receiver Signal
31	SRXN	I	SATA negative Receiver Signal
33	STXN	O	SATA negative Transmitter Signal
34	STXP	O	SATA positive Transmitter Signal
System Signals			
40	TEST_EN	I	Test Enable Signal, with internal pull-down resistor 0: Normal Mode (Default) 1: Test Mode Enable
48	I2C_DATA	B	Used as I2C_DATA signal or SPI_DI signal. Used as General Purpose IO after power on. Integrated pull-up resistor.
1	I2C_CLK	B	Used as I2C_CLK signal or SPI_CLK signal. Used as General Purpose IO after power on. Integrated pull-up resistor.
3	GPIO5	B	General Purpose IO, used as SPI_DO, with internal pull-up resistor.
4	GPIO4	B	General Purpose IO, used as SPI_CS0, with internal pull-up resistor.
6	GPIO3	B	General Purpose IO. Integrated pull-up resistor.
7	GPIO2	B	General Purpose IO, used as SPI_CS1 or LED2, with internal pull-up resistor.
38	UART_RX	B	URAT_RX while debug mode. Used as General Purpose IO after power on. Integrated pull-up resistor.
39	UART_TX	B	UART_TX while debug mode. Used as General Purpose IO after power on. Integrated pull-up resistor.
41	GPIO0	B	General Purpose IO. Integrated pull-up resistor.
42	GPIO1	B	General Purpose IO. Used as LED1. Integrated pull-up resistor.
43	HDDPC	B	HDD power control pin, use as General Purpose IO. Integrated pull-up resistor. 0: Hard Drive Power Off 1: Hard Drive Power On Note: It is strongly recommended to implement HDDPC control circuitry. To avoid power surge caused by some SATA drives, particularly SSDs, during power-up, proper RC delay or slew rate control is required in HDDPC circuitry. Please refer to reference design schematic and FAE for details.
10	VBUS	I	USB Cable Power Detector

Pin No.	Name	TYPE	Descriptions
26	REXT	P	External Reference Resistor with 12.1Kohm +/-1%
36	RST#	I	Power Reset pin
Clock Interface			
27	XI	I	Crystal input or Clock input pin
28	XO	O	Crystal output or Clock output pin
Type-C Interface			
8	CC1	B	Type-C Configuration Channel 1 for USB SuperSpeedPlus port0
9	CC2	B	Type-C Configuration Channel 2 for USB SuperSpeedPlus port1
Voltage Regulator			
11	VBUS_LDO	P	Linear regulator input Please always keep 5V input on this pin even if external 5V to 2.5V power solution is used.
12	VCC25O	P	Linear regulator output
47	VCCIN	P	Switching regulator input
46	LXI	P	Connect with external inductor
45	PGND	G	Ground for voltage regulator
Power and Ground			
15	VCCU	P	USB high power pin
35	VCCS	P	SATA high power pin
25	VDDU	P	USB low power pin
29	VDDS	P	SATA low power pin
5, 44	VDD	P	Core power
2, 37	VCC	P	IO power
20, 32	GNDA	G	Analog Ground
49	GND	G	the exposed pad connected to common ground on PCB

7. Electrical Characteristics

7.1 Absolute Maximum Ratings

Stressing the below parameters listed over the absolute maximum rating may cause the device permanent damage. This is a stress rating only, and the function operating of the device at these or any other conditions over these parameters in the recommended operating condition is not implied. It is recommended to have a clamp circuit to protect the device with abnormal exhibit voltage spikes while power is switched on or off.

Parameter	Range	Unit
Power Supply for VCC	-0.5 ~ VCC+0.5	V
Power Supply for VDD	-0.5 ~ VDD+0.5	
DC Input Voltage	-0.5 ~ VCC+0.5	V
Output Voltage	-0.5 ~ VCC+0.5	V
Storage Temperature	JEDEC J-STD-033B MSL 3	

7.2 Recommended Operating Conditions

Symbols	Parameter	Min.	Typ.	Max.	Units
V _{CC}	IO Power Supply	2.25	2.5/3.3	3.6	V
V _{CCU}	USB Analog High Power Supply	2.25	2.5	2.75	V
V _{CCS}	SATA Analog High Power Supply	2.25	2.5	2.75	V
V _{DD}	Core Power Supply	0.945	1.05	1.1025	V
V _{DDU}	USB Analog Low Power Supply	0.945	1.05	1.1025	V
V _{DDS}	SATA Analog Low Power Supply	0.945	1.05	1.1025	V
T _c	Operating Case Temperature			85	°C
T _j	Operating Junction Temperature	0	25	120	°C
HBM	Human Body mode ESD		2.5		KV
MM	Machine Mode ESD		150		V

Chip Temperature (T_a, T_j) Calculation

Symbols	Parameter	Min.	Typ.	Max.	Units
T _a	Ambient Temperature	Measure Temperature Around Chip			
T _j	Operating Junction Temperature	$T_j = \Theta_{ja} * Power + T_a$			
T _c	Operating Case Temperature	$T_c = T_j - \Psi_{jt} * Power$			
Θ_{ja}	Junction to Ambient Thermal Resistance	Provided by Package Vendor. For QFN48, $\Theta_{ja} = 30.7$			
Ψ_{jt}	Junction to Top Thermal Characterization	Provided by Package Vendor. For QFN48, $\Psi_{jt} = 0.11$			
Power	Chip Power Consumption	Measured Chip Power Consumption			

Note:

Thermal test board condition, please refer to JEDEC JESD51-5
 Thermal test method environmental conditions refer to JESD51-2
 Example: IF chip power consumption is 0.7W; T_a = 40°C
 $T_j = 30.7 * 0.7 + 40 = 61.49^\circ\text{C}$
 $T_c = 61.49 - 0.11 * 0.7 = 61.413^\circ\text{C}$

7.3 DC Electrical Characteristics for VBUS pin

Symbols	Parameter	VCC=3.3V			VCC=2.5V			Units
		Min.	Typ.	Max.	Min.	Typ.	Max.	
V _{IH}	Input High Voltage Level	2.0			1.7			V
V _{IL}	Input Low Voltage Level			0.8			0.6	V
V _{HYS}	Input Hysteresis	0.32	0.37	0.4	0.3	0.333	0.36	mV
V _{TH-L2H}	VTH of Schmitt Trigger low to high	1.4	1.6	1.8	1.1	1.294	1.5	V
V _{TH-H2L}	VTH of Schmitt Trigger high to low	1	1.23	1.4	0.8	0.961	1.1	V

7.4 DC Electrical Characteristics for GPIO pins

Symbols	Parameter	VCC=3.3V			VCC=2.5V			Units
		Min.	Typ.	Max.	Min.	Typ.	Max.	
V _{IH}	Input High Voltage Level	2.0			1.7			V
V _{IL}	Input Low Voltage Level			0.8			0.6	V
V _{HYS}	Input Hysteresis	0.32	0.37	0.4	0.3	0.333	0.36	mV
V _{TH-L2H}	VTH of Schmitt Trigger low to high	1.4	1.6	1.8	1.1	1.294	1.5	V
V _{TH-H2L}	VTH of Schmitt Trigger high to low	1	1.23	1.4	0.8	0.961	1.1	V
V _{OH}	Output High Voltage Level	2.4			2.0			V
V _{OL}	Output Low Voltage Level			0.4			0.3	V
I _{OH}	Output Driving Current @V _{OH}	12			8			mA
I _{OL}	Output Driving Current @V _{OL}	12			8			mA
R _{UP}	Internal Pull-up resistance while Vin=0V	65	96	140	86	136	210	KΩ
	Internal Pull-up resistance while Vin=VCC/2 V	38	56	81	48	75	114	KΩ
R _{DN}	Internal Pull-down resistance while Vin=VCC	59	96	142	71	126	200	KΩ
	Internal Pull-down resistance while Vin=VCC/2 V	35	55	79	39	68	106	KΩ
I _{IL-UP}	Input pull-up leakage current after Vin is read, Rup is off & Iil < 1uA when VIN=0	21	34.4	56	10	18.4	32	uA
	Input pull-up leakage current after Vin is read, Rup is off & Iil < 1uA when VIN=VCC/2	18	29.4	47	9.8	16.6	29	uA
I _{IL-DN}	Input pull-down leakage current after Vin is read, Rdn is off & Iil < 1uA when VIN=VCC	21	34.5	60	11	20	38.5	uA
	Input pull-down leakage current after Vin is read, Rdn is off & Iil < 1uA when VIN=VCC/2	18	30	50	10	18.5	35	uA

7.5 DC Electrical Characteristics for RST# pins

Symbols	Parameter	VCC=3.3V			VCC=2.5V			Units
		Min.	Typ.	Max.	Min.	Typ.	Max.	
V _{IH}	Input High Voltage Level	2.6			1.95			V
V _{IL}	Input Low Voltage Level			1.4			0.9	V
V _{HYS}	Input Hysteresis	0.21	0.23	0.25	0.2	0.22	0.25	mV
V _{TH-L2H}	VTH of Schmitt Trigger low to high	1.9	2.2	2.55	1.37	1.65	1.94	V
V _{TH-H2L}	VTH of Schmitt Trigger high to low	1.65	1.97	2.35	1.12	1.43	1.74	V
I _{IL}	Input pull-up leakage current while Vin=0V			1			1	uA

7.6 External Crystal Electrical Specification

Note: please refer to the figure 3

Symbol	Parameter	Min.	Typ	Max.	Unit
f_{XTAL}	Frequency		25		MHz
Δf_{XTAL}	Long Term Stability (at 25°C)	-30		30	ppm
T_c	Temperature Stability	-30		30	ppm
F_A	Aging	-5		5	ppm
C_L	Load Capacitance (Single-end mode)		16		pF
C_o	Shunt Capacitance	1	3	7	pF

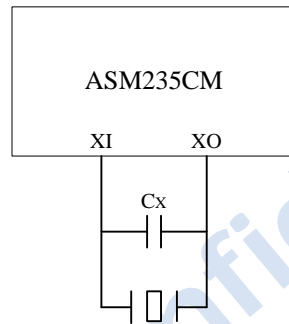

Figure 3: Differential Crystal Design

7.7 Differential Clock Oscillator Electrical Specification

Note: please refer to the figure 3

Symbol	Parameter	Min.	Typ	Max.	Unit
f_{CLK}	Frequency		25		MHz
Δf_{CLK}	Long Term Stability (all condition)	-150		150	ppm
C_x	External Load Capacitance (Differential mode)		10		pF
C_{TOTAL}	Total External Equivalent Capacitance from XI pin to XO pin (Differential mode)	9	11	15	Pf
R_{TOTAL}	Total External Equivalent Series Resistance from XI pin to XO pin			60	Ω

7.8 Internal Linear Regular Electrical Specification

Symbol	Parameter	Min.	Typ	Max.	Unit
V_{IN_LINEAR}	Input Voltage Range for internal linear regulator	4.0	5	5.5	V
V_{OUT_LINEAR}	Output Voltage Range for internal linear regulator	2.375	2.5	2.625	V
I_{MAX}	Maximum capacity of current output			230	mA

7.9 Internal Switching Regular Electrical Specification

Symbol	Parameter	Min.	Typ	Max.	Unit
V _{IN_SWITCH}	Input Voltage Range for internal switching regulator	4.0		5.5	V
V _{OUT_SWITCH}	Output Voltage Range for internal switching regulator	1.0	1.05	1.1	V
ΔV _N (p-p)	5V input voltage noise/ripple Range	-8		8	%
F _{OSC}	OSC frequency		1.5		MHz
I _{MAX}	Maximum capacity of current output			300	mA
I _{P(LM)}	P-channel current limiter		1		A

- **Strong recommendation to have 10uF decoupling capacitor placed close to pin47 to filter the noise/ripple of switching regulator input, VCCIN.**

7.10 USB Type-C CC Channel Specification

Symbols	Parameter	Min	Typ	Max	Unit	Remark
t _{CCDebounce}	Delay time for Debounce on CC bus while device attached	100		200	ms	

- **External resistors, R_d, are required to be pulled-down on CC1 and CC2.**

8. Power on Sequence

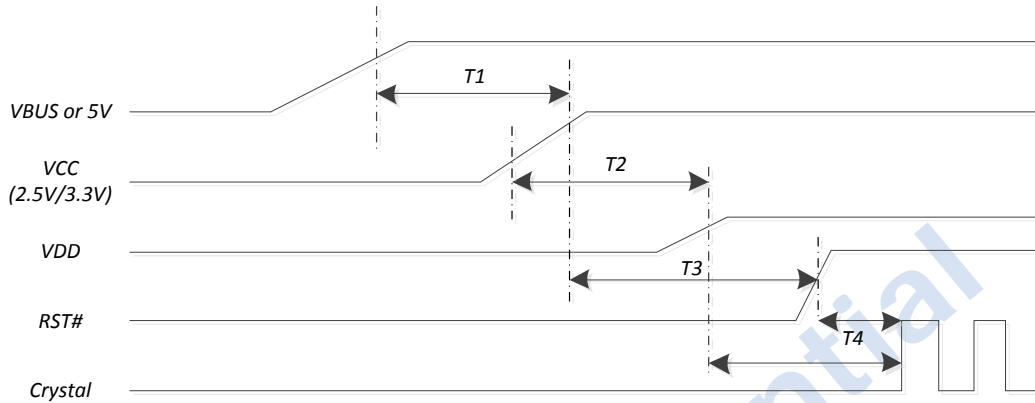

Figure 4: Timing diagram

Symbols	Parameter	Min	Typ	Max	Unit	Remark
T1	The delay of VCC after 5V or VBUS is available	0	5	10	ms	Measure from 90% of VCC Internal to 90% of 5V or VBUS
T2	The delay of VDD after VCC is available	N/A		90	ms	Measure from 10% of VCC to 90% of VDD
T3	The delay of RST# after VCC is available	0		N/A	ms	3.3V IO: Measure from 90% of VCC to 2V of RST# 2.5V IO: Measure from 90% of VCC to 1.7V of RST#
T4	The crystal clock is stable after RST# and VDD is available	22.3	65	107.2	ms	3.3V IO: Measure from 90% of VDD or 2V of RST# 2.5V IO: Measure from 90% of VDD or 1.7V of RST#
T_{SLEW-VBUS-5V}	Slew rate of VBUS or 5V	N/A		30	ms	Internal LDO: Measure from 10% to 90% of VBUS or 5V External LDO: No need to check this timing
T_{SLEW-VDD}	Slew rate of VDD	0		10	ms	Measure from 10% to 90% of VDD

9. PCB Design Guide under Thermal Pad

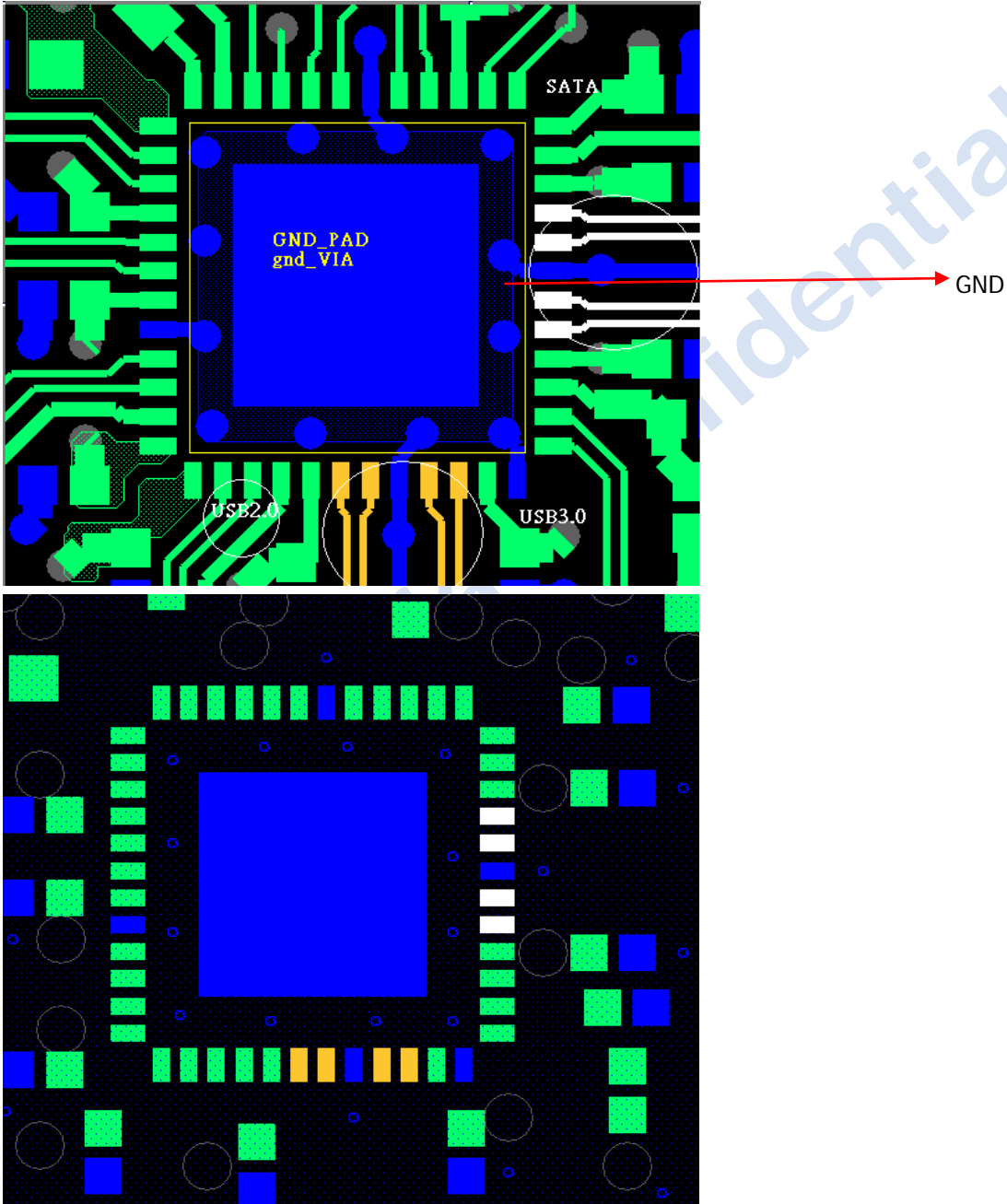
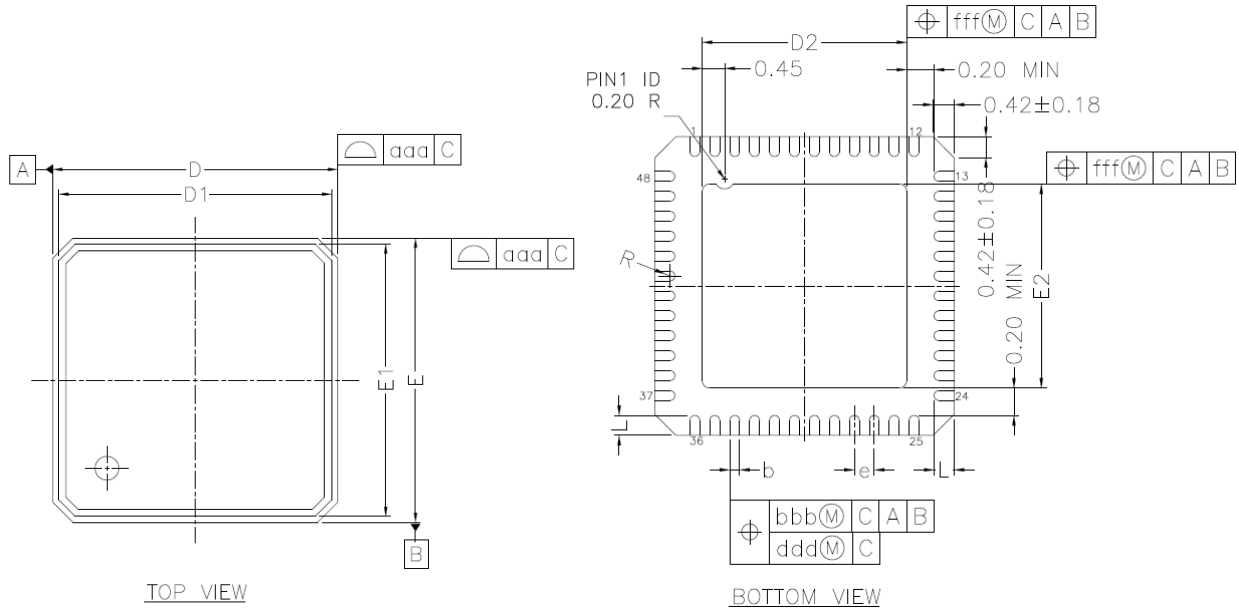

Figure 5: Symbol 1 for via design rule under Thermal pad

10. Package Information



* CONTROLLING DIMENSION : MM

SYMBOL	MILLIMETER			INCH		
	MIN.	NOM.	MAX.	MIN.	NOM.	MAX.
A	0.80	0.85	0.90	0.031	0.033	0.035
A1	0.00	0.02	0.05	0.00	0.001	0.002
A2	0.60	0.65	0.70	0.024	0.026	0.028
A3	0.20 REF.			0.008 REF.		
b	0.15	0.20	0.25	0.006	0.008	0.010
D	6.00 bsc			0.236 bsc		
D1	5.75 bsc			0.226 bsc		
D2	3.95	4.10	4.25	0.156	0.161	0.167
E	6.00 bsc			0.236 bsc		
E1	5.75 bsc			0.226 bsc		
E2	3.95	4.10	4.25	0.156	0.161	0.167
L	0.30	0.40	0.50	0.012	0.016	0.020
e	0.40 bsc			0.016 bsc		
θ1	0°	---	14°	0°	---	14°
R	0.075	---	---	0.003	---	---
TOLERANCES OF FORM AND POSITION						
aaa	---	---	0.10	---	---	0.004
bbb	---	---	0.07	---	---	0.003
ccc	---	---	0.10	---	---	0.004
ddd	---	---	0.05	---	---	0.002
eee	---	---	0.08	---	---	0.003
fff	---	---	0.10	---	---	0.004

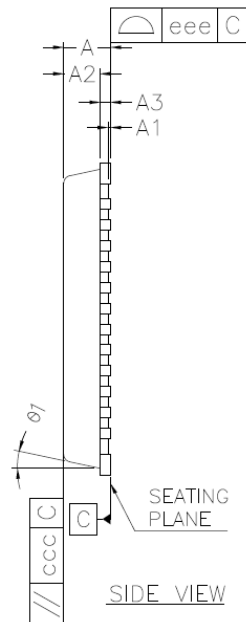

NOTES :

- 1.ALL DIMENSIONS ARE IN MILLIMETERS.
- 2.DIE THICKNESS ALLOWABLE IS 0.305 mm MAXIMUM(.012 INCHES MAXIMUM)
- 3.DIMENSIONING & TOLERANCES CONFORM TO ASME Y14.5M. -1994.
- 4.DIMENSION APPLIES TO PLATED TERMINAL AND IS MEASURED BETWEEN 0.20 AND 0.25 mm FROM TERMINALTIP.
- 5.THE PIN #1 IDENTIFIER MUST BE PLACED ON THE TOP SURFACE OF THE PACKAGE BY USING INDENTATION MARK OR OTHER FEATURE OF PACKAGE BODY.
- 6.EXACT SHAPE AND SIZE OF THIS FEATURE IS OPTIONAL.
- 7.PACKAGE WARPAGE MAX 0.08 mm.
- 8.APPLIED FOR EXPOSED PAD AND TERMINALS. EXCLUDE EMBEDDING PART OF EXPOSED PAD FROM MEASURING.
- 9.APPLIED ONLY TO TERMINALS.
- 10.PACKAGE CORNERS UNLESS OTHERWISE SPECIFIED ARE $R0.175\pm0.025$ mm.

Figure 6: Mechanical Specification – QFN 48

ASMedia Confidential

11. Top Marking Information

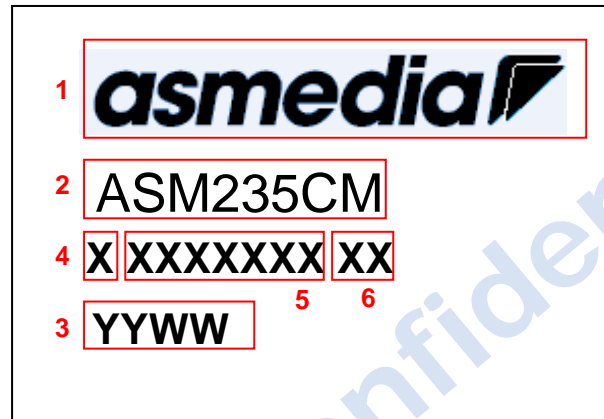

1. **asmedia**: ASMedia Logo
2. **ASM235CM**: Product Name
3. **YYWW**: Date Code
4. **X**: Version of Marking Rule
5. **XXXXXXXX**: Serial No. reserved for vendor
6. **XX**: Version code